

User Manual

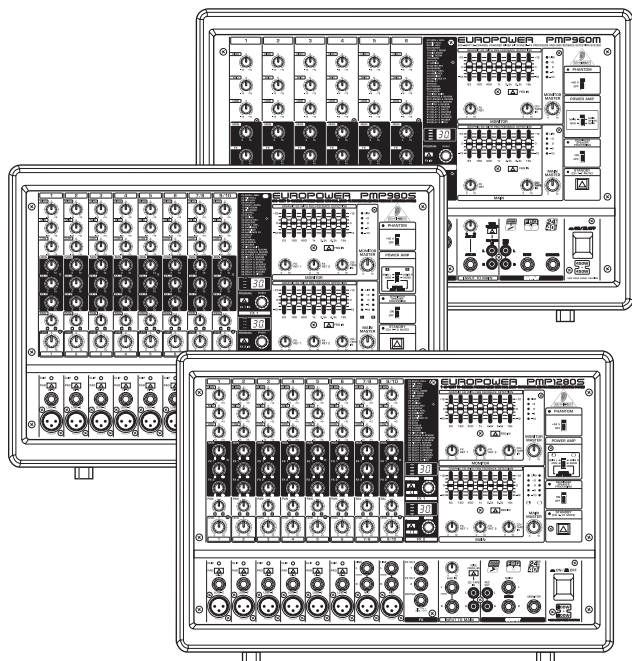

EUROPOWER PMP960M/PMP980S/ PMP1280S

**900/1,200-Watt 6/10-Channel
Powered Mixer with Dual
Multi-FX Processor and FBQ
Feedback Detection System**

Thank you

Thank you for choosing one of the PMP series powered mixers from BEHRINGER. These mixers pack impressive features such as digital effects, graphic EQs, FBQ feedback destroyer and unique voice cancelling function – all in a lightweight, portable package. You now have a versatile combination of inputs, routing options, effects and power amp operations for your rehearsal space, small venue or portable PA needs. But why bother with manuals? We know you want to get started right away, but please read this manual carefully and keep it handy for ongoing reference. These instructions show you all the inside features, tricks, and tips you need to build the best possible sound with your new PMP powered mixer.

After all, it's all about *your sound*.

This manual is available in English, German, French, Spanish, Italian, Russian, Polish, Dutch, Finnish, Swedish, Danish, Portuguese, Greek, Japanese and Chinese. There may also be more current versions of this document. Download them by going to the appropriate product page at:

www.behringer.com

XXX-XXXX-XXXX

Table of Contents

Thank you	1
Important Safety Instructions	2
1. Before you get started	3
2. Control Elements	3
3. Digital Effects Processor	6
4. Installation	6
5. Wiring Examples	9
6. Specifications	11
Legal Disclaimer	13
Waranty	14



Important Safety Instructions



Terminals marked with this symbol carry electrical current of sufficient magnitude to constitute risk of electric shock. Use only high-quality commercially-available speaker cables with ¼" TS plugs pre-installed. All other installation or modification should be performed only by qualified personnel.



This symbol, wherever it appears, alerts you to the presence of uninsulated dangerous voltage inside the enclosure - voltage that may be sufficient to constitute a risk of shock.



This symbol, wherever it appears, alerts you to important operating and maintenance instructions in the accompanying literature. Please read the manual.



Caution

To reduce the risk of electric shock, do not remove the top cover (or the rear section). No user serviceable parts inside. Refer servicing to qualified personnel.



Caution

To reduce the risk of fire or electric shock, do not expose this appliance to rain and moisture. The apparatus shall not be exposed to dripping or splashing liquids and no objects filled with liquids, such as vases, shall be placed on the apparatus.



Caution

These service instructions are for use by qualified service personnel only. To reduce the risk of electric shock do not perform any servicing other than that contained in the operation instructions. Repairs have to be performed by qualified service personnel.

- ① Read these instructions.
- ② Keep these instructions.
- ③ Heed all warnings.
- ④ Follow all instructions.
- ⑤ Do not use this apparatus near water.

- ⑥ Clean only with dry cloth.
- ⑦ Do not block any ventilation openings. Install in accordance with the manufacturer's instructions.
- ⑧ Do not install near any heat sources such as radiators, heat registers, stoves, or other apparatus (including amplifiers) that produce heat.
- ⑨ Do not defeat the safety purpose of the polarized or grounding-type plug. A polarized plug has two blades with one wider than the other. A grounding-type plug has two blades and a third grounding prong. The wide blade or the third prong are provided for your safety. If the provided plug does not fit into your outlet, consult an electrician for replacement of the obsolete outlet.
- ⑩ Place the power cord so that it is protected from being walked on and sharp edges. Be sure that the power cord is protected particularly at plugs, convenience receptacles and the point where it exits from the apparatus.
- ⑪ The apparatus shall be connected to a MAINS socket outlet with a protective earthing connection.
- ⑫ Where the MAINS plug or an appliance coupler is used as the disconnect device, the disconnect device shall remain readily operable.
- ⑬ Only use attachments/accessories specified by the manufacturer.
- ⑭ Use only with the cart, stand, tripod, bracket, or table specified by the manufacturer, or sold with the apparatus. When a cart is used, use caution when moving the cart/apparatus combination to avoid injury from tip-over.
- ⑮ Unplug this apparatus during lightning storms or when unused for long periods of time.
- ⑯ Refer all servicing to qualified service personnel. Servicing is required when the apparatus has been damaged in any way, such as power supply cord or plug is damaged, liquid has been spilled or objects have fallen into the apparatus, the apparatus has been exposed to rain or moisture, does not operate normally, or has been dropped.



1. Before you get started

1.1 Shipment

Your PMP mixer was carefully packed at the factory and the packaging is designed to protect the unit from rough handling. Nevertheless, we recommend that you carefully examine the packaging and its contents for any signs of physical damage which may have occurred during transit.

- ◆ **If the unit is damaged, please do NOT return it to BEHRINGER, but notify your dealer and the shipping company immediately. Otherwise, claims for damage or replacement may not be granted.**
- ◆ **We recommend that you use a flight case, so as to give your power mixer optimum protection during use or transport.**
- ◆ **Always use the original packing carton to prevent damage during storage or transport.**
- ◆ **Make sure that children cannot play unsupervised with the device or its packaging.**
- ◆ **Please ensure proper disposal of all packing materials.**

1.2 Initial operation

Be sure that there is enough air space around the unit for cooling and, to avoid overheating, please do not place the EUROPOWER near radiators, etc.

- ◆ **Blown fuses must be replaced by fuses of the same type and rating! Please refer to the “Specifications” for details.**

The mains connection is made using the enclosed power cord and a standard IEC receptacle. It meets all of the international safety certification requirements.

- ◆ **Please make sure that all units have proper ground connection. For your own safety, never remove or disable the ground conductor from the unit or on the AC power cord.**
- ◆ **Important notes concerning installation: The sound quality may diminish within the range of powerful broadcasting stations and high-frequency sources. Increase the distance between the transmitter and the device and use shielded cables for all connections.**

1.3 Online registration

Please do remember to register your new BEHRINGER equipment right after your purchase by visiting www.behringer.com (alternatively www.behringer.de) and kindly read the terms and conditions of our warranty carefully.

Should your BEHRINGER product malfunction, our goal is to have it repaired as quickly as possible. To arrange for warranty service, please contact the retailer from whom the equipment was purchased. Should your BEHRINGER dealer not be located in your vicinity, you may directly contact one of our subsidiaries. Corresponding contact information is included in the original equipment packaging (Global Contact Information/European Contact Information). Should your country not be listed, please contact the distributor nearest you. A list of distributors can be found in the support area of our website (www.behringer.com). Registering your purchase and equipment with us helps us process your repair claims quicker and more efficiently.

Thank you for your cooperation!

1.4 The manual

This manual is designed to give you both an overview of all control elements and to provide detail about how to use them. To provide you with a clear structure, we have grouped the control elements according to their function. They can easily be found on the enclosed numbered illustrations. If you need more detailed information on specific topics, please visit our web site www.behringer.com. The product-related information pages and the Ultratnet-based glossary explain the relevant audio engineering terminology in full detail.

Front Panel

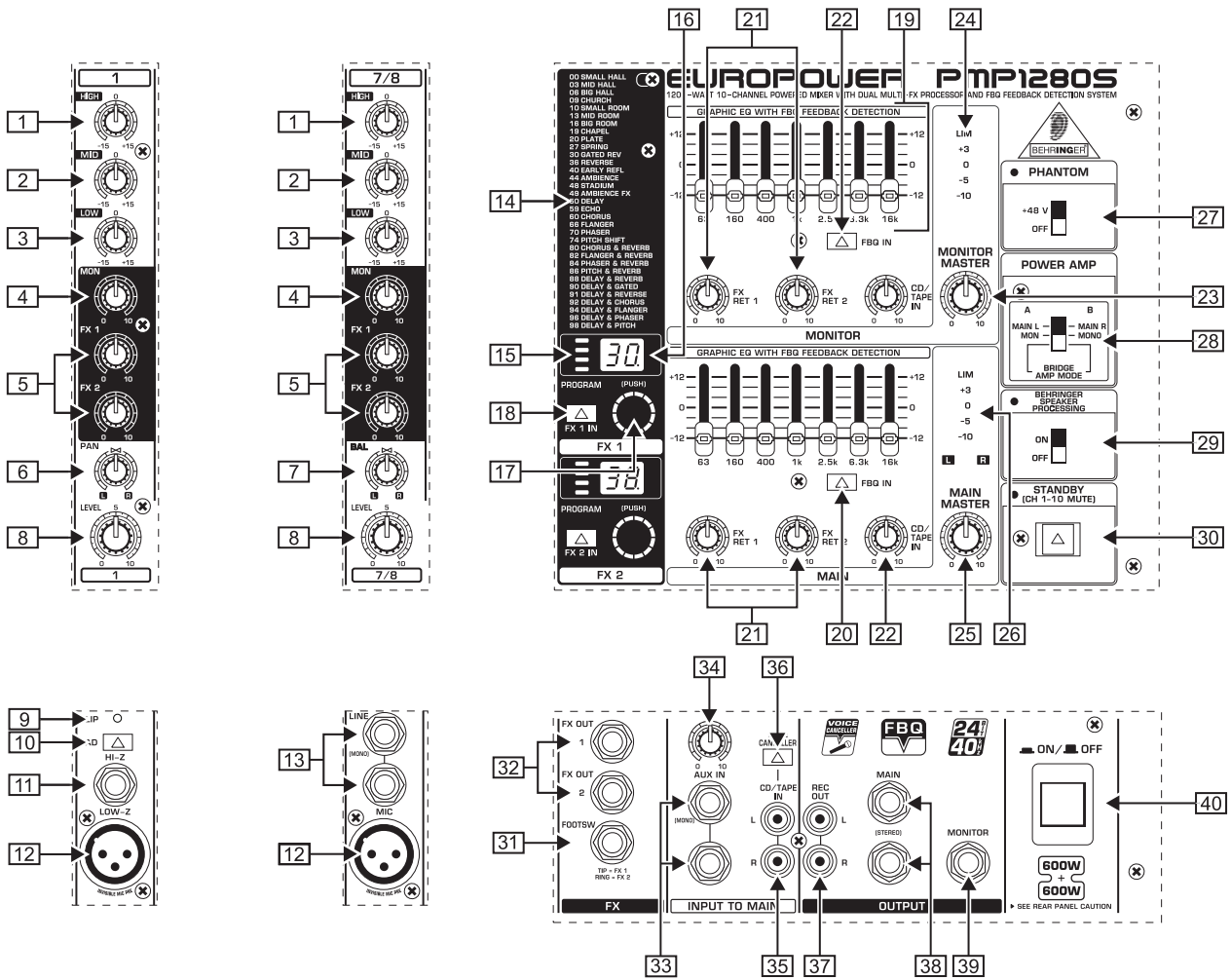

Rear Panel

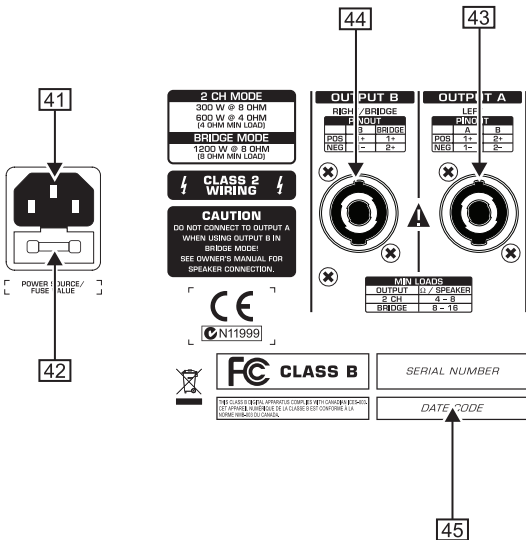

2. Control Elements

A detailed description of all functions of your power mixer can be found in the following chapters. Please also refer to the enclosed sheet with the numbered illustrations to get an overview of the control layout.

2.1 Mono and stereo channels

- ① The HIGH control in the EQ section governs the high-frequency range of the respective channel.
- ② Use the MID control to boost or cut the mid-range frequencies.
- ③ The LOW control allows you too boost/cut the low-frequency range.
- ④ With the MON control you can adjust the volume of each channel in the monitor mix.
- ⑤ The FX control determines the signal level sent from each channel to the built-in effects processor; this signal is also present at the FX OUT jack (see ③②). The PMP980S/PMP1280S has two FX controls (FX 1 and FX 2), so that you can use two effects simultaneously. Accordingly, it also provides two effect Aux paths (see ③②).

◆ Please note that the effects processor signal will be inaudible when the FX RETURN control ②① is set fully counter-clockwise.

- ⑥ For the mono input channels, the PMP980S/PMP1280S has a PAN(ORAMA) control which determines the position of the channel signal in the stereo main mix. The PMP960M has no PAN on the input channels, because it is a dual-mono power mixer.
- ⑦ The BAL(ANCE) control for the stereo channels of the PMP980S/PMP1280S corresponds to the PAN control for the mono channels. It determines the relative volume of the left and right input signals before they are routed to the stereo main output. The PMP960M has no stereo channels and hence no BAL control, because it is a dual-mono power mixer.
- ⑧ The LEVEL control adjusts the channel signal level in the main mix.

2.1.1 Input section

- ⑨ The CLIP LED is very useful to control the input gain. It should never be constantly illuminated (only with signal peaks).
- ⑩ The PAD switch reduces the input sensitivity of the channel by approx. 30 dB, to connect for example line-level signals.
- ⑪ The balanced HI-Z input (¼" TRS) can be used for line-level signal sources, e.g. keyboards, electric guitars and basses.

- ⑫ Each channel has a balanced LOW-Z microphone input with XLR connectors, which also supply the +48 V phantom power for condenser microphones (see ②⑦).
- ⑬ Unbalanced stereo line inputs with ¼" connectors for stereo channels 7 to 10 of the PMP980S/PMP1280S. They can be used for connecting keyboards with stereo outputs or stereo drum machines.

◆ Please remember to use either the microphone or the line input of a channel at a time, but never both at the same time!

2.2 Effects section

- ⑭ List of all multi-effects presets.
- ⑮ LED level meter of the effects processor. Since the PMP980S/PMP1280S allows you to select two effects simultaneously, it also has two level meters (DUAL FX). Be sure that the clip LED illuminates for signal peaks only. If it is illuminated all the time, it is a sign that the effects processor is overloading and hence producing unpleasant distortion.
- ⑯ The Effect display (PMP980S/PMP1280S: two displays) shows the currently selected preset.
- ⑰ Turn the PROGRAM control (PMP980S/PMP1280S: one control each for FX 1 and FX 2) to select an effects preset (preset number starts flashing). Push the control briefly to confirm your selection.
- ⑱ Press the FX IN button (PMP980S/PMP1280S: FX 1 IN and FX 2 IN) to activate the effects processor.

2.3 Main and monitor section

- ⑲ Your power mixer is equipped with two graphic 7-band equalizers. The upper one processes the monitor signal, the lower one the main signal. Use the EQs to adjust the sound to the room acoustics.
- ⑳ Press the FBQ IN switch to activate the FBQ Feedback Detection System. The frequencies causing feedback are shown by the brightly lit fader LEDs. Simply lower the level of the respective frequency range until feedback disappears and the LED goes out. Your power mixer offers this function both for the main and the monitor mix.
- ㉑ Turn the FX RET control to add the effect signal to the main mix (lower) or monitor mix (upper). The PMP980S/PMP1280S allows you to use two effects at the same time, it also has two FX controls each for the main and monitor mixes: when the FX RET 1 and FX RET 2 controls are fully counterclockwise, no effect signal is added.
- ㉒ The CD/TAPE IN control adjusts the volume of the 2 Track In signal (see ③⑤).
- ㉓ The MONITOR MASTER control adjusts the monitor output volume.

- 24 Use this 5-digit LED meter to control the output level of the monitor signal. The upper LIM LED illuminates when the internal amp protection circuit responds to output levels that are too high.
- 25 The MAIN MASTER control is used to adjust the main output volume.
- 26 Use this 5-digit LED meter to control the output level of the main signal. The PMP980S/PMP1280S has two rows of LED meters (L/R), because the signal is stereo. The upper LIM LED illuminates when the internal amp protection circuit responds to output levels that are too high.
- 27 +48V phantom power is provided for condenser microphones. The phantom power supply is activated for all channels with the PHANTOM switch and the PHANTOM LED above the switch illuminates.
- 28 Use the POWER AMP switch to determine the operating mode of your power mixer.

The PMP980S/PMP1280S has three different operating modes: In MAIN L/MAIN R mode it functions as a stereo amplifier, i.e. the left and right main stereo signals are sent to OUTPUT A (L) and OUTPUT B (R). In MON/MONO mode it functions as a dual mono amplifier, i. e. OUTPUT A sends the monitor signal, and OUTPUT B the main signal (mono). In BRIDGE AMP MODE the output power of outputs A and B are added and provided at OUTPUT B. The PMP960M also has three operating modes, since it can be operated in two modes with the switch in its upper position (MAIN/MAIN (BRIDGE) mode), depending on the pin connections of the speaker cables. In MAIN/MAIN (BRIDGE) mode power of both outputs is added and provided at OUTPUT B (Locking cable, pins 1+/2+). With the normal pin connections (Locking cable, pins 1+/1-) a main signal is provided in this mode at OUTPUT A and B (not bridged). In MON/MAIN mode, the mixer can also be used as a dual mono amplifier, i.e. OUTPUT A provides the monitor signal, while the main signal is present at OUTPUT B.

Please refer to 44 and 45 as well as chapter 4.4 “Loudspeaker connectors”.

- ◆ In BRIDGE mode, always connect only one loudspeaker with an impedance of at least 8 Ω to OUTPUT B (pins 1+/2+)! Please note that OUTPUT A must NEVER be used in BRIDGE mode (with pin connections 1+/2+)!
- ◆ In all other operating modes, the minimum impedance of the speaker connected must not fall below 4 Ω.
- 29 Use the SPEAKER PROCESSING switch to activate a filter that adapts the mixer to the specifications of your loudspeakers. If the speakers have a limited frequency response in the bass range, it allows you to adapt it optimally to the frequency response of the speakers.

- 30 If STANDBY is pressed, all input channels are muted. During breaks you can thus prevent the microphones from picking up noise or interference, which would then be reproduced by the P.A. system. The advantage is that all faders can be left untouched while you play a CD via the CD/TAPE inputs (see 35). There is also no need to move down the faders of muted channels and lose your mix.

2.3.1 Connectors

- 31 The FOOTSWITCH connector is for a standard footswitch. You can activate an “effect bypass” that mutes the effects processor. Please use a dual footswitch for the PMP980S/PMP1280S, so that you can enable/disable FX1 and FX2 independently of each other. In this case, the tip of the ¼" plug controls FX1, and the ring FX2.
- 32 The FX OUT connector is used to route the FX SEND signal from the input channels, for example, to the input of an external effects processor. The PMP980S/PMP1280S has two FX controls per input signal (see 5) and also two FX OUT connectors (FX OUT 1 and FX OUT 2).

◆ Please note: When you connect a mono plug to one of the FX OUT jacks, the signal path from the respective FX send to the built-in effects processor is interrupted. For each FX send you can either use the built-in effect or the corresponding FX OUT jack (for an external effect), but never both at the same time. When you use a stereo plug (tip and ring interconnected) you can use the built-in effects processor and the FX OUT jacks in parallel.

- 33 Use the AUX IN ¼" inputs to route an external stereo signal to the main mix. This can be the signal generated by an external effects processor. Use the left input for mono signals, which are then reproduced on both stereo sides. The PMP960M has only one mono AUX IN connector.
- 34 The AUX IN control adjusts the volume of the external signal in the main mix.
- 35 The CD/TAPE IN RCA input allows you to feed in external stereo signals, e.g. from a CD player, tape deck or other line-level source.
- 36 The VOICE CANCELLER filters vocal-specific frequencies from the CD/TAPE IN signal. This function can be used for karaoke, i.e. you can remove the vocals from a song and then sing along with the music yourself.
- 37 The REC OUT (RCA) provides line-level signals from the power mixer to a DAT recorder, for example. On the PMP980S/PMP1280S the REC OUT signal is stereo and on the PMP960M two identical mono signals are provided.
- ◆ If the REC OUT signal is connected to a recorder whose output signal is returned to the CD/TAPE IN, feedback can occur when you activate the record function. So, discon-

nect the CD/TAPE IN from the recorder, before you start recording!

- 39 The MAIN ¼" connectors allow you to send the main signal to an external amplifier, when you only wish to use the mixer and effects section. The signal is taken pre-power stage of the mixer. It is also possible to use only the left jack of the output. The PMP960M has only one mono output connector.
- 39 Connect your monitor power amps or active monitor speakers to the mono MONITOR output to monitor the signal mix created with the MON controls or to route it to the musicians on stage.
- 40 Use the POWER switch to put the unit into operation. The POWER switch should always be in the "Off" position when you are about to connect the unit to the mains.
- ♦ **Please note: The POWER switch does not fully disconnect the unit from the mains. Unplug the power cord completely when the unit is not used for prolonged periods of time.**

2.4 Rear panel

- 41 The mains connection is on a standard IEC receptacle. An appropriate power cord is supplied with the unit.
- 42 FUSE HOLDER. Before connecting the unit to the mains, ensure that the voltage setting matches your local voltage. Blown fuses should only be replaced by fuses of the same type and rating. Please also read the information given in chapter 6 "Specifications".
- 43 Loudspeaker OUTPUT A.
PMP980S/PMP1280S: Depending on the operating mode selected (see 28) either the left main signal or the monitor signal is provided at OUTPUT A. Never use this output in bridged mono mode.
PMP960M: In MON/MAIN mode, the monitor signal is provided at OUTPUT A (see 28). Never use this output in bridged mono mode, except when you use a cable with the normal pin connections (pins 1+/1-). In this case you can take the mono main signal from this output in MAIN/MAIN (BRIDGE) mode (not bridged). Please also refer to chapter 4.3 "Loudspeaker connection".
- ♦ **The impedance of the loudspeaker connected must not fall below 4 Ω.**
- ♦ **Please note that the power delivered to the speaker in bridged mono mode is considerably higher than in other operating modes. Please read the information given on the rear panel of the power mixer.**
- 44 Loudspeaker OUTPUT B.
PMP980S/PMP1280S: Depending on the operating mode selected (see 28) either the right main signal, the mono main signal or the bridged mono signal is provided at

OUTPUT B.

PMP960M: Either the main or the bridged main mono signal is provided at OUTPUT B (see 28). When you use a cable with the normal pin connections (pins 1+/1-), it is possible in MAIN/MAIN (BRIDGE) mode to take the mono main signal from this output (not bridged). Please also refer to chapter 4.3 "Loudspeaker connection".

- ♦ **In BRIDGE mode, always connect only one loudspeaker with an impedance of at least 8 Ω to OUTPUT B (pins 1+/2+)! Please note that OUTPUT A must NEVER be used in BRIDGE mode (with pin connections 1+/2+)!**
- ♦ **In all other operating modes, the minimum impedance of the speaker connected must not fall below 4 Ω.**
- ♦ **Information on how to properly connect your speaker with regard to polarity can be found on the rear of the mixer (PINOUTs).**

45 SERIAL NUMBER.

3. Digital Effects Processor

24-BIT MULTI-EFFECTS PROCESSOR

This built-in effects module produces high-grade standard effects such as reverb, chorus, flanger, delay and various combination effects. The integrated effects module has the advantage of requiring no wiring. This way, the danger of creating ground loops or uneven signal levels is eliminated at the outset, completely simplifying the handling.

These effect presets are designed to be added to dry signals. If you move the FX RET control, you mix the channel signal (dry) and the effect signal.

- ♦ **Turn down the FX controls in those channel strips whose signals you don't wish to process.**

4. Installation

4.1 Mains connection

Blown fuses must be replaced by fuses of the same type and rating.

The mains connection is made using the enclosed power cord and a standard IEC receptacle. It meets all of the international safety certification requirements.

- ♦ **Please make sure that all units have a proper ground connection. For your own safety, never remove or disable the ground conductor from the unit or of the AC power cord.**

4.2 Audio connections

The inputs and outputs of the BEHRINGER EUROPOWER are unbalanced ¼" TS connectors—except for the balanced mono line inputs. Of course, all inputs and outputs work with both bal-

anced and unbalanced connectors. The Tape Ins and Outs are on stereo RCA connectors.

◆ Please ensure that only qualified personnel install and operate the power mixer. During installation and operation, the user must have sufficient electrical contact to earth. Electrostatic charges might affect the operation of the unit.

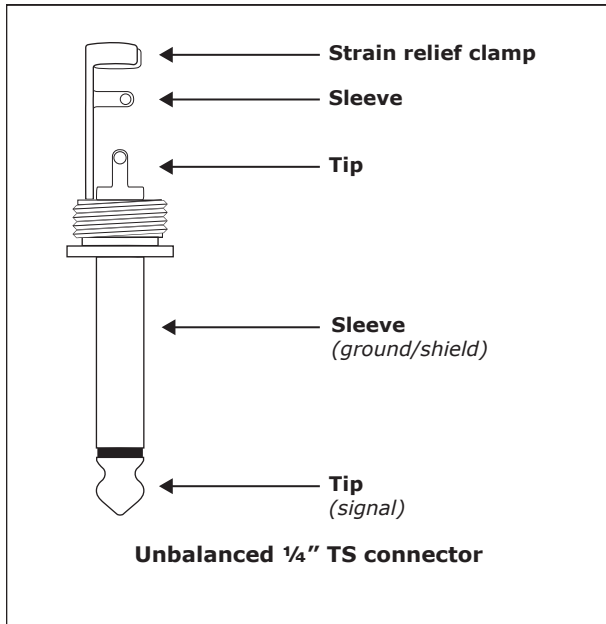

Fig. 4.1: 1/4" TS connector

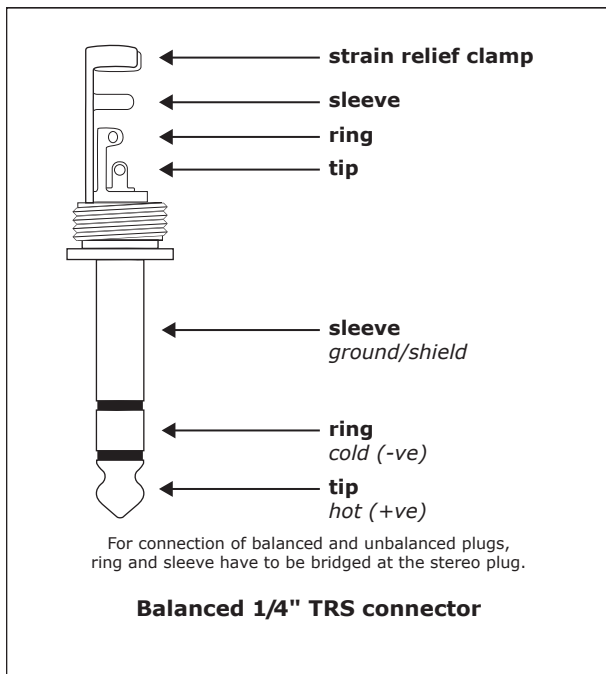

Fig. 4.2: 1/4" TRS connector

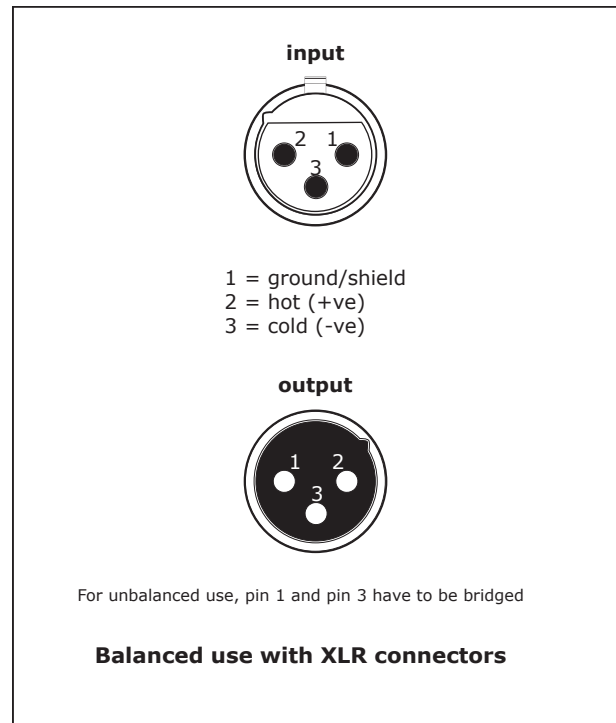

Fig. 4.3: XLR connectors

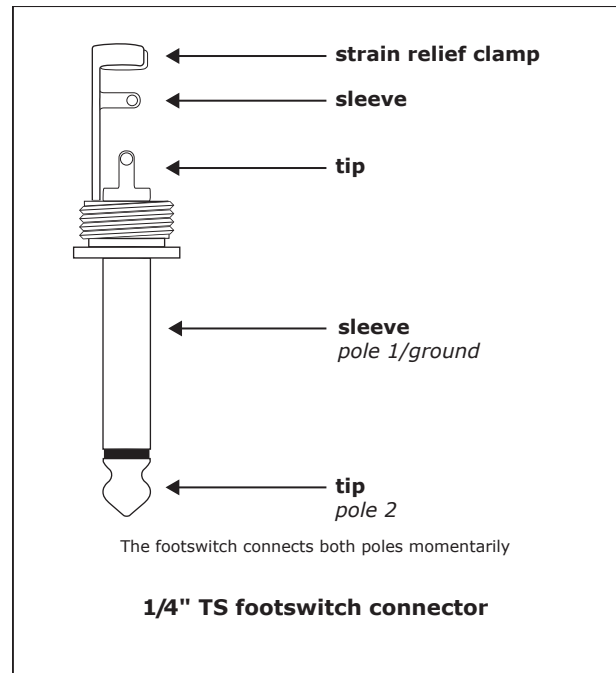

Fig. 4.4: 1/4" TS connector for footswitch

◆ Please use a dual footswitch for the PMP980S/PMP1280S, so that you can enable/disable FX1 and FX2 independently of each other. In this case, the tip of the ¼" plug controls FX1, and the ring FX2.

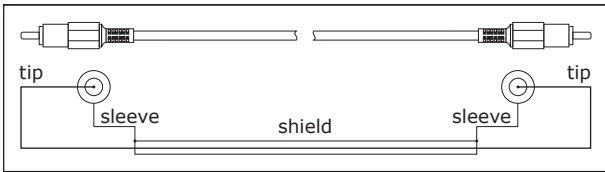

Fig. 4.5: RCA cable

4.3 Loudspeaker connection

Your PMP mixer is equipped with high-quality twist-lock professional style loudspeaker connectors, which ensure safe and trouble-free operation. This connector was especially developed for high-power loudspeakers. Once it is plugged in, it safely locks into position and cannot be accidentally disengaged. It prevents the occurrence of electrical shock and ensures the correct polarity. Each of the connectors carries only the assigned single signal (see tab. 4.1/fig. 4.7 and the information on the rear panel of the power mixer).

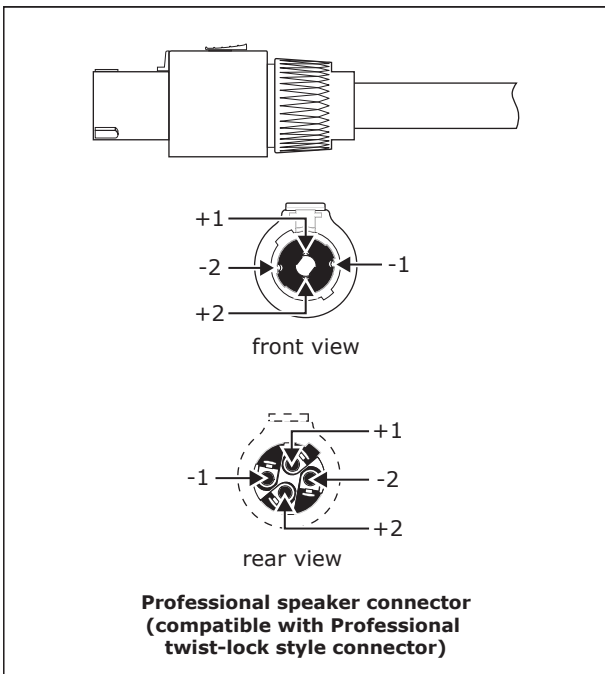

Fig. 4.6: Professional twist-lock style connector

Please be sure to only use professional locking-style speaker cables (type NL4FC). Please check the pin connections of your loudspeakers and cables depending on the EUROPOWER speaker output you choose.

EUROPOWER PMP980S/PMP1280S				
OUTPUT A	1+	1-	2+	2-
MAIN L	POS	NEG	-	-
MON	POS	NEG	-	-
OUTPUT B	-	-	POS	NEG
OUTPUT B	1+	1-	2+	2-
MAIN R	POS	NEG	-	-
MONO	POS	NEG	-	-
BRIDGE	POS	-	NEG	-

EUROPOWER PMP960M				
OUTPUT A	1+	1-	2+	2-
MAIN MONO	POS	NEG	-	-
MON	POS	NEG	-	-
BRIDGE	-	-	-	-
OUTPUT B	1+	1-	2+	2-
MAIN MONO	POS	NEG	-	-
MAIN	POS	NEG	-	-
BRIDGE	POS	-	NEG	-

Tab 4.1: Pin connections of loudspeaker connectors

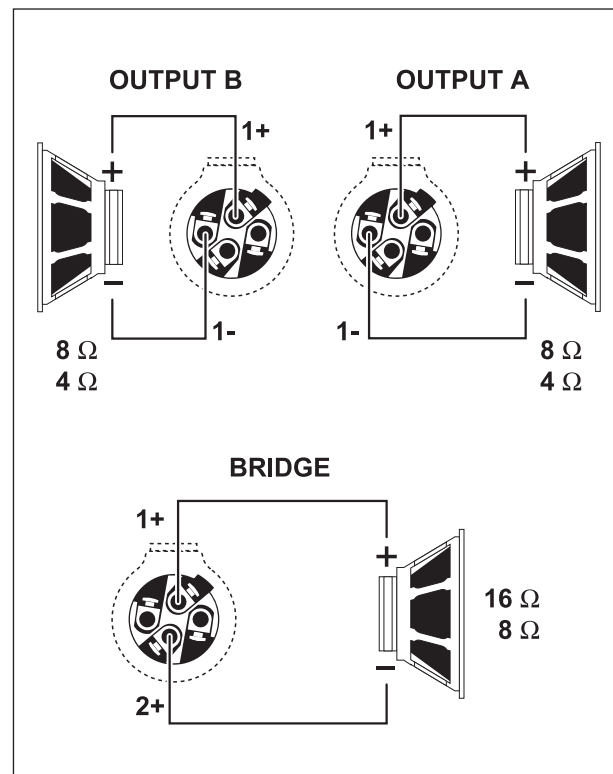

Fig. 4.7: Connector assignment

5. Wiring Examples

For stereo operation the POWER AMP switch [28] of the PMP980S/PMP1280S must be set to its upper position (MAIN L/MAIN R). Outputs A and B deliver the stereo main signal to the P.A. speakers. Two active speakers, wired in parallel, are connected to the preamp monitor output. They are used as on-stage monitor speakers. The effects processors can be switched on and off with a dual footswitch. This set-up is not possible with the PMP960M (no stereo operation possible).

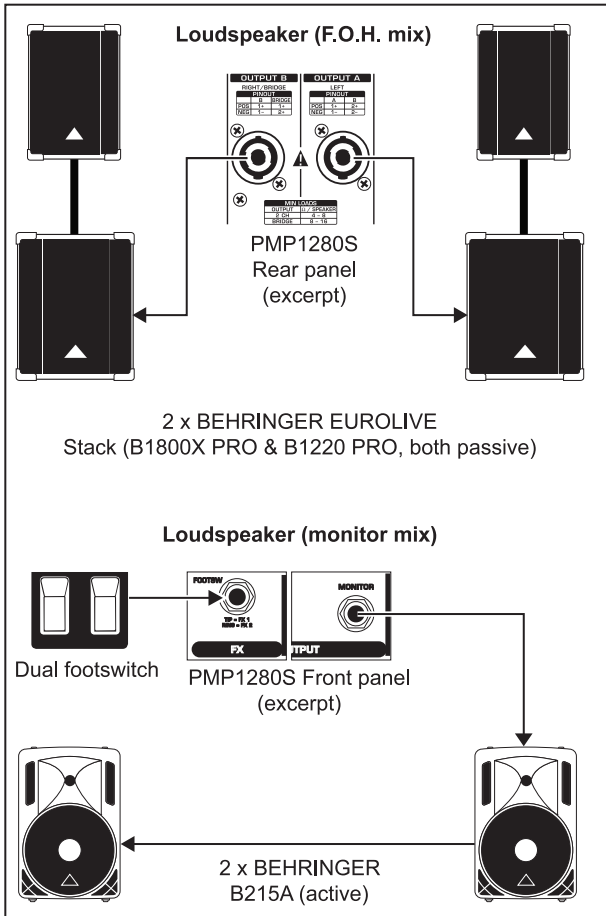

Fig. 5.1: EUROPOWER mixer as a stereo amplifier (example)

Both the PMP980S/PMP1280S and the PMP960M can be set-up for dual mono operations. The POWER AMP switch [28] must be set to its lower (PMP960M) or center position (PMP980S/PMP1280S). The two loudspeaker outputs provide the main and monitor signals independently of each other and to two loudspeakers each, which are wired in parallel.

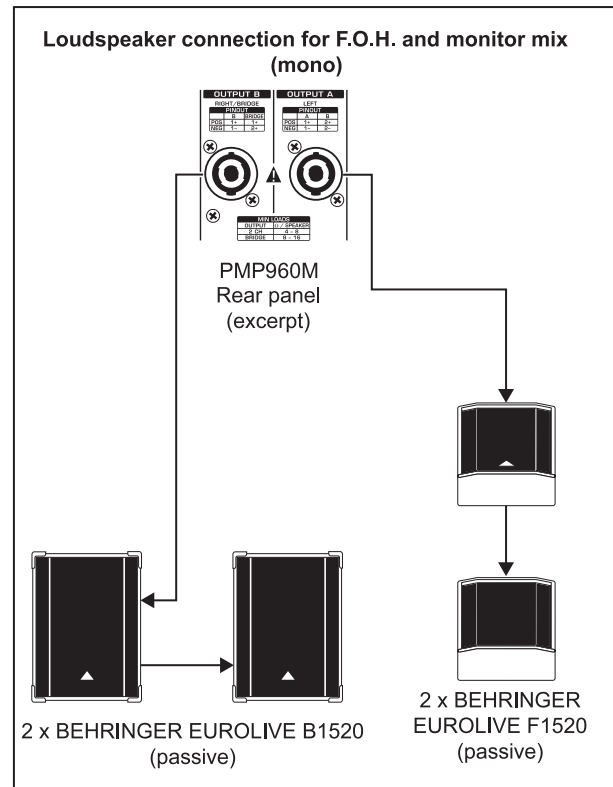

Fig. 5.2: EUROPOWER as a dual mono amplifier (example)

This illustration shows just one example of how the channels of your power mixer can be used, including the connection of mono and stereo sources, and the tape ins and outs recording the mix signal or playing back external signals.

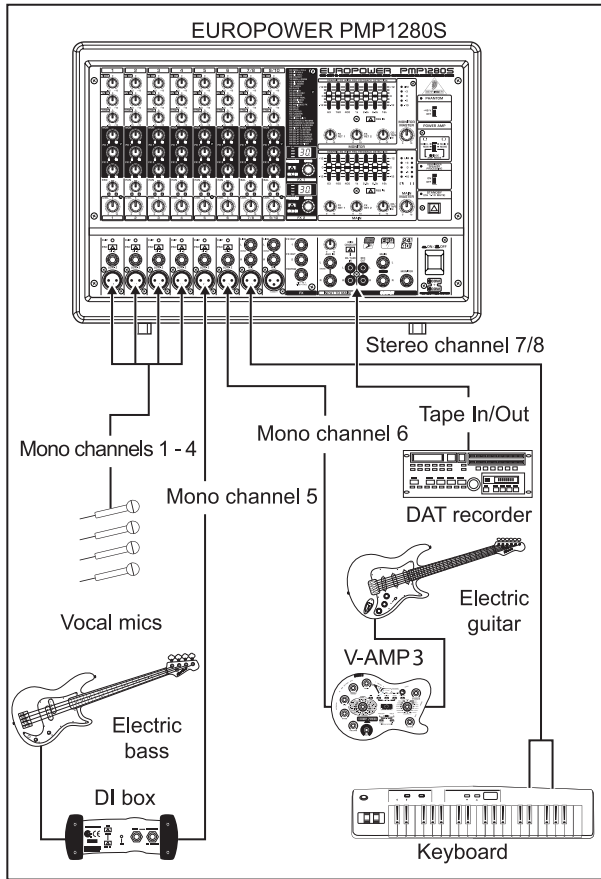

Fig. 5.3: Standard set-up (example)

One example of how to use your power mixer with a subwoofer in bridged mono mode. The illustration shows the PMP1280S with a subwoofer connected to OUTPUT B that will receive the full (bridged) output power. A separate stereo power amp (BEHRINGER EUROPOWER EP2000) for the stereo main P.A. signal is connected to the Pre Amp Main outputs. The Pre Amp monitor output is wired to active speakers on the stage. This application can also be realized with the PMP960M, except for the main P.A. signal, which would be mono.

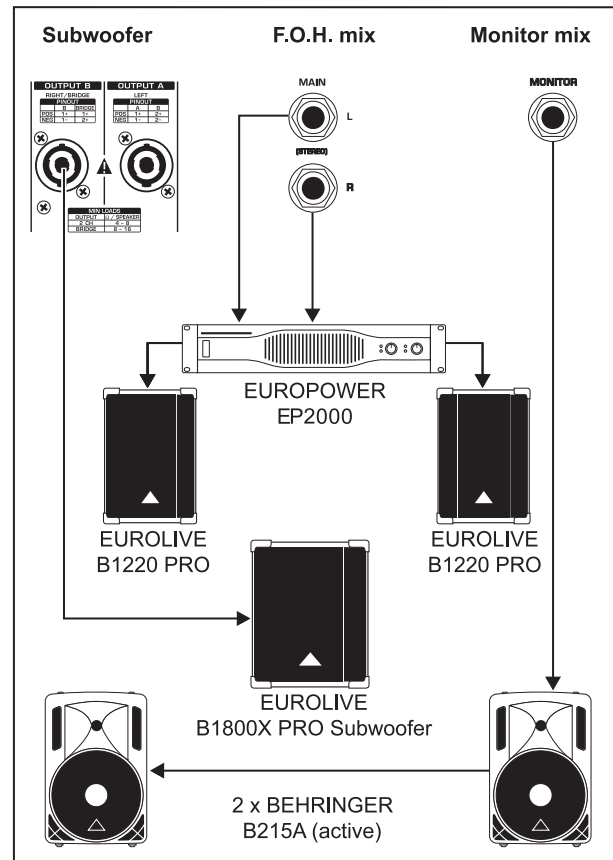

Fig. 5.4: EUROPOWER in bridged mono mode

6. Specifications

MICROPHONE INPUTS

Type	XLR, electronically balanced input circuit
------	--

Mic E.I.N. (20 Hz - 20 kHz)

@ 0 Ohm source resistance	-112 dB / 114 dB A-weighted
@ 50 Ohm source resistance	-112 dB / 114 dB A-weighted
@ 150 Ohm source resistance	-112 dB / 114 dB A-weighted
Frequency response	< 10 Hz - 200 kHz (-1 dB) < 10 Hz - > 200 kHz (-3 dB)
Gain	+30 dB, +10 dB with pad
Max. input level	+12 dBu @ +10 dB gain
Impedance	approx. 2.2 kOhm balanced / 1.1 kOhm unbalanced
Signal-to-noise ratio	110 dB / 114 dB A-weighted (0 dBu In @ +10 dB gain)
Noise (THD + N)	0.001% / 0.0007% A-weighted

MONO LINE INPUTS

Type	¼" TS connectors, balanced
Impedance	approx. 20 kOhm, balanced
Max. input level	+21 dBu

STEREO LINE INPUTS

PMP960M

Type	-
Impedance	-
Max. input level	-

PMP980S

Type	¼" TRS connectors, unbalanced
Impedance	approx. 100 kOhm, unbalanced
Max. input level	+21 dBu

PMP1280S

Type	¼" TRS connectors, unbalanced
Impedance	approx. 100 kOhm, unbalanced
Max. input level	+21 dBu

EQUALIZER

Low	80 Hz / +/-15 dB
Mid	2.5 kHz / +/-15 dB
High	12 kHz / +/-15 dB

CD/TAPE INPUT

Type	RCA
Impedance	approx. 10 kOhm

PREAMP OUTPUTS

MAIN

Type	¼" TS connectors, unbalanced
Impedance	approx. 150 Ohm, unbalanced
Max. output level	+21 dBu

MONITOR

Type	¼" TS connectors, unbalanced
Impedance	approx. 150 Ohm, unbalanced
Max. output level	+21 dBu

STEREO OUTPUTS

PMP960M

Type	-
Impedance	-
Max. input level	-

PMP980S

Type	¼" TRS connectors, unbalanced
Impedance	approx. 150 Ohm, unbalanced
Max. input level	+21 dBu

PMP1280S

Type	¼" TRS connectors, unbalanced
Impedance	approx. 150 Ohm, unbalanced
Max. input level	+21 dBu

PMP960M

Type	RCA, mono output
Impedance	approx. 1 kOhm
Max. input level	+21 dBu

PMP980S

Type	RCA
Impedance	approx. 1 kOhm
Max. input level	+21 dBu

PMP1280S

Type	RCA
Impedance	approx. 1 kOhm
Max. input level	+21 dBu

MAIN MIX SYSTEM DATA

Noise:

MAIN MIX @ -?	
Channel fader -?	-102 dB/-106 dB A-weighted
MAIN MIX @ 0 dB	
Channel fader -?	-88 dB/-91 dB A-weighted
MAIN MIX @ 0 dB	
Channel fader @ 0 dB	-84 dB/-86 dB A-weighted

LOUDSPEAKER OUTPUTS

Type	Professional twist-lock style connector
------	---

Load impedance:**PMP960M**

MAIN L/R	-
----------	---

PMP980S

MAIN L/R	4 - 8 Ohm
----------	-----------

PMP1280S

MAIN L/R	4 - 8 Ohm
----------	-----------

PMP960M

MONITOR/MAIN MONO	4 - 8 Ohm
-------------------	-----------

MAIN MONO/MAIN MONO	4 - 8 Ohm
---------------------	-----------

BRIDGE	8 - 16 Ohm
--------	------------

PMP980S

MONITOR/MAIN MONO	4 - 8 Ohm
-------------------	-----------

MAIN MONO/MAIN MONO	4 - 8 Ohm
---------------------	-----------

BRIDGE	8 - 16 Ohm
--------	------------

PMP1280S

MONITOR/MAIN MONO	4 - 8 Ohm
-------------------	-----------

MAIN MONO/MAIN MONO	4 - 8 Ohm
---------------------	-----------

BRIDGE	8 - 16 Ohm
--------	------------

DSP

Converter	24-bit Delta-Sigma, 64/128-times oversampling
-----------	---

Dynamics D/A	90 dB
--------------	-------

Sampling rate	40 kHz
---------------	--------

Delay Time	max. 5 secs
------------	-------------

Signal run time (Line In > Line Out)	approx. 1.5 ms
---	----------------

DISPLAY**PMP960M**

Type	2-digit, 7-segment LED
------	------------------------

PMP980S/PMP1280S

Type	2 x 2-digit, 7-segment LED
------	----------------------------

OUTPUT POWER**RMS @ 1% THD (sine wave), both channels driven:****PMP960M**

8 Ohm per channel	165 W
-------------------	-------

PMP980S

8 Ohm per channel	165 W
-------------------	-------

PMP1280S

8 Ohm per channel	215 W
-------------------	-------

PMP960M

4 Ohm per channel	250 W
-------------------	-------

PMP980S

4 Ohm per channel	250 W
-------------------	-------

PMP1280S

4 Ohm per channel	450 W
-------------------	-------

RMS @ 1% THD (sine wave), bridged mode:**PMP960M**

8 Ohm	500 W
-------	-------

PMP980S

8 Ohm	500 W
-------	-------

PMP1280S

8 Ohm	900 W
-------	-------

Peak Power, both channels driven:**PMP960M**

8 Ohm per channel	225 W
-------------------	-------

PMP980S

8 Ohm per channel	225 W
-------------------	-------

PMP1280S

8 Ohm per channel	300 W
-------------------	-------

PMP960M

4 Ohm per channel	350 W
-------------------	-------

PMP980S

4 Ohm per channel	350 W
-------------------	-------

PMP1280S

4 Ohm per channel	600 W
-------------------	-------

Peak Power, bridged mode:**PMP960M**

8 Ohm	900 W
-------	-------

PMP980S

8 Ohm	900 W
-------	-------

PMP1280S

8 Ohm	1200 W
-------	--------

FUSES**PMP1280S**

100 - 120 V~, 50/60 Hz	T 10 A H 250 V
------------------------	----------------

220 - 240 V~, 50/60 Hz	T 6.3 A H 250 V
------------------------	-----------------

POWER CONSUMPTION

Power consumption	1000 W
-------------------	--------

Mains connector	IEC standard receptacle
-----------------	-------------------------

14**DIMENSIONS/WEIGHT**

Dimensions (H x W x D)	approx. 12 ² / ₅ " x 18 ¹ / ₁₀ " x 8 ³ / ₅ "
	approx. 315 mm x 460 mm x 220 mm

PMP960M

Weight	8.5 kg, 18 ³ / ₄ lbs.
--------	---

PMP980S

Weight	9.4 kg, 20 ³ / ₄ lbs.
--------	---

PMP1280S

Weight	10.6 kg, 23 ¹ / ₃ lbs.
--------	--

BEHRINGER is constantly striving to maintain the highest professional standards. As a result of these efforts, modifications may be made from time to time to existing products without prior notice.

Specifications and appearance may differ from those listed or illustrated.

Warranty

§ 1 Warranty

① This limited warranty is valid only if you purchased the product from a BEHRINGER authorized dealer in the country of purchase. A list of authorized dealers can be found on BEHRINGER's website www.behringer.com under "Where to Buy", or you can contact the BEHRINGER office closest to you.

② BEHRINGER* warrants the mechanical and electronic components of this product to be free of defects in material and workmanship if used under normal operating conditions for a period of one (1) year from the original date of purchase (see the Limited Warranty terms in § 4 below), unless a longer minimum warranty period is mandated by applicable local laws. If the product shows any defects within the specified warranty period and that defect is not excluded under § 4, BEHRINGER shall, at its discretion, either replace or repair the product using suitable new or reconditioned product or parts. In case BEHRINGER decides to replace the entire product, this limited warranty shall apply to the replacement product for the remaining initial warranty period, i.e., one (1) year (or otherwise applicable minimum warranty period) from the date of purchase of the original product.

③ Upon validation of the warranty claim, the repaired or replacement product will be returned to the user freight prepaid by BEHRINGER.

④ Warranty claims other than those indicated above are expressly excluded.

PLEASE RETAIN YOUR SALES RECEIPT. IT IS YOUR PROOF OF PURCHASE COVERING YOUR LIMITED WARRANTY. THIS LIMITED WARRANTY IS VOID WITHOUT SUCH PROOF OF PURCHASE.

§ 2 Online registration

Please do remember to register your new BEHRINGER equipment right after your purchase at www.behringer.com under "Support" and kindly read the terms and conditions of our limited warranty carefully. Registering your purchase and equipment with us helps us process your repair claims quicker and more efficiently. Thank you for your cooperation!

§ 3 Return authorization number

① To obtain warranty service, please contact the retailer from whom the equipment was purchased. Should your BEHRINGER dealer not be located in your vicinity, you may contact the BEHRINGER distributor for your country listed under "Support" at www.behringer.com. If your country is not listed, please check if your problem can be dealt with by our "Online Support" which may also be found under "Support" at www.behringer.com. Alternatively, please submit an online warranty claim at www.behringer.com BEFORE returning the product. All inquiries must be accompanied by a description of the problem and the serial number of the product. After verifying the product's warranty eligibility with the original sales receipt, BEHRINGER will then issue a Return Materials Authorization ("RMA") number.

② Subsequently, the product must be returned in its original shipping carton, together with the return authorization number to the address indicated by BEHRINGER.

③ Shipments without freight prepaid will not be accepted.

§ 4 Warranty Exclusions

① This limited warranty does not cover consumable parts including, but not limited to, fuses and batteries. Where applicable, BEHRINGER warrants the valves or meters contained in the product to be free from defects in material and workmanship for a period of ninety (90) days from date of purchase.

② This limited warranty does not cover the product if it has been electronically or mechanically modified in any way. If the product needs to be modified or adapted in order to comply with applicable technical or safety standards on a national or local level, in any country which is not the country for which the product was originally developed and manufactured, this modification/adaptation shall not be considered a defect in materials or workmanship. This limited warranty does not cover any such modification/adaptation, regardless of whether it was carried out properly or not. Under the terms of this limited warranty, BEHRINGER shall not be held responsible for any cost resulting from such a modification/adaptation.

③ This limited warranty covers only the product hardware. It does not cover technical assistance for hardware or software usage and it does not cover any software products whether or not contained in the product. Any such software is provided "AS IS" unless expressly provided for in any enclosed software limited warranty.

④ This limited warranty is invalid if the factory-applied serial number has been altered or removed from the product.

⑤ Free inspections and maintenance/repair work are expressly excluded from this limited warranty, in particular, if caused by improper handling of the product by the user. This also applies to defects caused by normal wear and tear, in particular, of faders, crossfaders, potentiometers, keys/buttons, tubes, guitar strings, illuminants and similar parts.

⑥ Damage/defects caused by the following conditions are not covered by this limited warranty:

- improper handling, neglect or failure to operate the unit in compliance with the instructions given in BEHRINGER user or service manuals;
- connection or operation of the unit in any way that does not comply with the technical or safety regulations applicable in the country where the product is used;
- damage/defects caused by acts of God/Nature (accident, fire, flood, etc) or any other condition that is beyond the control of BEHRINGER.

⑦ Any repair or opening of the unit carried out by unauthorized personnel (user included) will void the limited warranty.

⑧ If an inspection of the product by BEHRINGER shows that the defect in question is not covered by the limited warranty, the inspection costs are payable by the customer.

⑨ Products which do not meet the terms of this limited warranty will be repaired exclusively at the buyer's expense. BEHRINGER or its authorized service center will inform the buyer of any such circumstance. If the buyer fails to submit a written repair order within 6 weeks after notification, BEHRINGER will return the unit C.O.D. with a separate invoice for freight and packing. Such costs will also be invoiced separately when the buyer has sent in a written repair order.

⑩ Authorized BEHRINGER dealers do not sell new products directly in online auctions. Purchases made through an online auction are on a "buyer beware" basis. Online auction confirmations or sales receipts are not accepted for warranty verification and BEHRINGER will not repair or replace any product purchased through an online auction.

§ 5 Warranty transferability

This limited warranty is extended exclusively to the original buyer (customer of authorized retail dealer) and is not transferable to anyone who may subsequently purchase this product. No other person (retail dealer, etc.) shall be entitled to give any warranty promise on behalf of BEHRINGER.

§ 6 Claim for damage

Subject only to the operation of mandatory applicable local laws, BEHRINGER shall have no liability to the buyer under this warranty for any consequential or indirect loss or damage of any kind. In no event shall the liability of BEHRINGER under this limited warranty exceed the invoiced value of the product.

§ 7 Limitation of liability

This limited warranty is the complete and exclusive warranty between you and BEHRINGER. It supersedes all other written or oral communications related to this product. BEHRINGER provides no other warranties for this product.

§ 8 Other warranty rights and national law

- ① This limited warranty does not exclude or limit the buyer's statutory rights as a consumer in any way.
- ② The limited warranty regulations mentioned herein are applicable unless they constitute an infringement of applicable mandatory local laws.
- ③ This warranty does not detract from the seller's obligations in regard to any lack of conformity of the product and any hidden defect.

§ 9 Amendment

Warranty service conditions are subject to change without notice. For the latest warranty terms and conditions and additional information regarding BEHRINGER's limited warranty, please see complete details online at www.behringer.com.

* BEHRINGER Macao Commercial Offshore Limited of Rue de Pequim No. 202-A, Macau Finance Centre 9/J, Macau, including all BEHRINGER group companies

Legal Disclaimer

Technical specifications and appearance are subject to change without notice. The information contained herein is correct at the time of printing. BEHRINGER accepts no liability for any loss which may be suffered by any person who relies either wholly or in part upon any description, photograph or statement contained herein. Colors and specifications may vary slightly from product. BEHRINGER products are sold through authorized dealers only. Distributors and dealers are not agents of BEHRINGER and have absolutely no authority to bind BEHRINGER by any express or implied undertaking or representation. This manual is copyrighted. No part of this manual may be reproduced or transmitted in any form or by any means, electronic or mechanical, including photocopying and recording of any kind, for any purpose, without the express written permission of Red Chip Company Ltd.

ALL RIGHTS RESERVED. © 2009 Red Chip Company Ltd.
Trident Chambers, Wickhams Cay, P.O. Box 146,
Road Town, Tortola, British Virgin Islands



This manual is available in English, German, French, Spanish, Italian, Russian, Polish, Dutch, Finnish, Swedish, Danish, Portuguese, Greek, Japanese and Chinese. There may also be more current versions of this document. Download them by going to the appropriate product page at:

www.behringer.com